

Instruction Manual

— Disc sander

— TS 301



TS 301

TS 301

Imprint

Product identification

Disc Sander	Item number
TS 301	5904300

Manufacturer

Stürmer Maschinen GmbH
 Dr.-Robert-Pfleger-Str. 26
 D-96103 Hallstadt/Bamberg

Fax: 049 (0) 951 96555 - 55

E-Mail: info@holzkraft.de
 Internet: www.holzkraft.de

Indications regarding the operating instructions

Original Instruction
 according to DIN EN ISO 20607:2019

Edition: 25.05.2021
 Version: 1.06
 Language: English

Author: ES

Indications regarding the copyright

Copyright © 2021 Stürmer Maschinen GmbH, Hallstadt, Germany.

Technical changes and errors excepted.

Contents

1 Introduction	3
1.1 Copyright	3
1.2 Customer service.....	3
1.3 Limitation of liability.....	3
2 Safety	3
2.1 Symbol explanation	3
2.2 Obligations of the operating company	4
2.3 Qualification of personnel	4
2.4 Personal protective equipment	5
2.5 Safety signs on the Machine.....	5
2.6 Safety data sheets	6
3 Intended Use	6
3.1 Predictable misuse	6
3.2 Residual risks	6
3.3 Electrical Connection	6
4 Technical Data.....	7
4.1 Table.....	7
4.2 Type plate.....	7
5 Transport, packaging, storage.....	7
5.1 Delivery and Transport	7
5.2 Packaging.....	8
5.3 Storage	8
6 Description of the device	8
6.1 Scope of supply	8
6.2 Accessories	8
7 Assembly and commissioning of the disc sander	8
7.1 Assembly	9
7.2 Commissioning	9
8 Operation and settings.....	9
8.1 Adjusting the angle at the work table to the sanding pad	9
8.2 Adjusting the miter angle on the work table.....	10
8.3 Replacing the grinding wheel.....	10
8.4 Connection to an extraction system.....	11
8.5 Grinding	11
9 Care, maintenance and repair.....	12
9.1 Cleaning after work.....	12
9.2 Maintenance and repair	13
10 Troubleshooting.....	13
11 Disposal, recycling of old equipment..	13
11.1 Decommission	13
11.2 Disposal of electrical appliances.....	13
11.3 Disposal of lubricants.....	14
11.4 Disposal via municipal collection points.....	14
12 Spare parts.....	14
12.1 Ordering spare parts.....	14
12.2 Spare parts drawing TS 301.....	15
13 Wiring Diagram.....	16
14 EC-Declaration of Conformity.....	17

1 Introduction

With the purchase of the disc sander from HOLZKRAFT you have made a good choice.

Read the operating instructions carefully before commissioning.

This informs you about the proper commissioning, the intended use as well as the safe and efficient operation and maintenance of your device.

The operating instructions are part of the device. Always keep these operating instructions in the place where you use your device. In addition, observe the local accident prevention regulations and general safety regulations for the area of application of the device.

1.1 Copyright

The contents of these instructions are protected by copyright and are the sole property of Stürmer Maschinen GmbH. Their use is permitted within the scope of use of the disc grinder. Any other use is not permitted without the written consent of the manufacturer.

Passing on as well as duplication of this document, utilization and communication of its contents are forbidden, as far as not expressly permitted. We register trademark, patent and design rights for the protection of our products, insofar as this is possible in individual cases. We emphatically oppose any infringement of our intellectual property.

1.2 Customer service

Please contact your dealer if you have questions on the machine or if you need technical advice. They will help you with specialist information and expert advice.

Germany:

Stürmer Maschinen GmbH
Dr.-Robert-Pfleger-Str. 26
D-96103 Hallstadt

Repair service:

Fax: 049 (0) 951 96555-111
E-Mail: service@stuermer-maschinen.de

Spare part orders:

Fax: 049 (0) 951 96555-119
E-Mail: ersatzteile@stuermer-maschinen.de

We are always interested in valuable experience and knowledge gained from using the application, which then could be shared and be valuable to develop our products even further.

1.3 Limitation of liability

All information and notes in these operating instructions were summarised taking the applicable standards and rules, the state-of-the-art and our long-term knowledge and experiences into consideration.

In the following cases the manufacturer is not liable for damages:

- Non-observance of the operating instructions,
- Inappropriate use
- Use of untrained staff,
- Unauthorised modifications
- Technical changes,
- Use of not allowed spare parts.

The actual scope of delivery may deviate from the explanations and presentations described here in case of special models, when using additional ordering options or due to latest technical modifications.

The obligations agreed in the delivery contract, the general terms and conditions as well as the delivery conditions of the manufacturer and the legal regulations at the time of the conclusion of the contract are applicable.

2 Safety

This paragraph will give you an overview of all important safety packages for the protection of the people using it well as for a safe and undisturbed operation. Other task-based safety notes are included in the individual chapters

2.1 Symbol explanation

Safety instructions

The safety notes in these operating instructions are highlighted by symbols. The safety notes are introduced by signal words which express the concern of the risk.



DANGER!

This combination of symbol and signal words indicates an imminently dangerous situation which may lead to death or severe injuries if they are not avoided.



WARNING!

This combination of symbol and signal word indicates a potentially dangerous situation that can lead to death or serious injury if not avoided.



CAUTION!

This combination of symbol and signal word indicates a potentially dangerous situation that can result in minor injury if it is not avoided.



ATTENTION!

This combination of symbol and signal words indicates a possibly dangerous situation which may lead to property and environmental damages if they are not avoided.



NOTE!

This combination of symbol and signal words indicates a possibly dangerous situation which may lead to property and environmental damages if they are not avoided.

Tips and recommendations



Tips and recommendations

This symbol highlights useful tips and recommendations as well as information for an efficient and trouble-free operation.

It is necessary to observe the safety notes quoted in these operating instructions in order to reduce the risks for personal injuries and damages to property.

2.2 Obligations of the operating company

The operating company is the person who operates the machine for business or commercial reasons by herself, or leaves it to a third party for use or application, and who bears the legal product responsibility for the protection of the user, the staff or for third parties.

Obligations of the operating company:

If the machine is used for commercial purposes, the operating company must comply with the legal working safety regulations. Therefore, the safety notes in this operating manual, as well as the safety, accident prevention and environment protection regulations applying for the area of application of the machine must be met. The following applies in particular:

- The operating company must be informed about the applying industrial safety regulations and further analyse hazards resulting from the special working conditions at the place of use machine. She must implement these in form of operating manuals for the operation machine.

- During the entire lifetime of machine, the operating company must verify whether the operating manuals prepared by her correspond to the current status of the regulations, and must adapt these if necessary.
- The operating company must unambiguously regulate and determine the responsibilities for installation, operation, troubleshooting, maintenance and cleaning.
- The operating company must ensure that all persons who work with machine, have read and understood this manual. Furthermore she must instruct the staff in regular intervals and inform them about the hazards.
- The operator must provide the necessary protective equipment to the staff and order the use of the necessary protective equipment in a binding way.

Furthermore the operating company is responsible to keep the Machine always in a technically flawless state. Thus, the following applies:

- The operator must ensure that the maintenance intervals described in this manual are kept.
- The operator must have all safety devices checked regularly for their good working order and their integrity.

2.3 Qualification of personnel

The different tasks described in this manual represent different requirements to the qualification of the persons entrusted with these tasks.



WARNING!

Danger in case of insufficient qualification of the staff!

Insufficiently qualified persons cannot estimate the risks while using machine and expose themselves and others to the danger of severe injuries.

- Have all works only performed by qualified persons.
- Keep insufficiently qualified persons and children out of the working area.

Only persons reliable working procedures can be expected from, are allowed to perform all works. Persons the responsiveness of which is affected by e. g. drugs, alcohol or medication, are not allowed to work with the machine.

The qualifications of the personnel for the different tasks are mentioned below:

Operator:

The operator is instructed by the operating company about the assigned tasks and possible risks in case of improper behaviour. Any tasks which need to be performed beyond the operation in the standard mode must only be performed by the operator if it is indicated in these instructions and if the operating company expressly commissioned the operator.

Electrical specialist:

Due to his professional training, knowledge and experience as well as his knowledge of respective standards and regulations the electrical specialist is able to perform works on the electrical system and to recognise and avoid any possible dangers himself.

Specialist staff:

Due to their professional training, knowledge and experience as well as their knowledge of relevant regulations the specialist staff is able to perform the assigned tasks and to recognise and avoid any possible dangers themselves.

Manufacturer:

Certain works may only be performed by specialist personnel of the manufacturer. Other personnel is not authorized to perform these works. Please contact our customer service for the execution of all arising work..

2.4 Personal protective equipment

The personal protective equipment serves to protect persons against impairments of safety and health while working. The staff has to wear personal protective equipment while performing different works on and with grinding system which are indicated in the individual paragraphs of these instructions.

The personal protective equipment is explained in the following paragraph:



Hearing protection

Hearing protection helps to protect your hearing from harmful noise and other loud noises.



Breathing protection

Breathing protection is used to protect the respiratory tract and lungs against the absorption of dust particles.



Eye protection

The protective goggles protect the eyes against parts flying off and splashes of liquids.



Protective gloves

The protective gloves serve to protect the hands against sharp components as well as against friction, abrasions or deep injuries.



Safety boots

The safety boots protect the feet against crushes, falling parts and slipping over on slippery underground.



Protective clothes

The protective clothes are tight clothes of little tensile strength.

2.5 Safety signs on the Machine

The following safety signs and notes are applied on the grinding system (Fig. 1), which need to be observed and followed.



Fig. 1: Safety labels

Damaged or missing safety symbols at the machine may lead to errors with personal and material damages. The safety symbols which are applied on the machine must not be removed. Damaged safety symbols must be replaced immediately. The machine must be put out of operation from the moment when the labels are unable to be recognized and understood at first glance, until new labels are attached.

2.6 Safety data sheets

Safety data sheets for hazardous materials can be obtained from your specialist dealer or by phone: +49 (0)951/96555-0. Specialist dealers can find safety data sheets in the download area of the partner portal.

3 Intended Use

The disc sander TS 301 is used exclusively for sanding wood and wood-like materials (wood fiber board, chip-board, plywood boards, laminated and non-laminated boards, etc.). It must be connected to a suitable extraction system. The disc sander is suitable for private use, not for industrial use. Proper use also includes compliance with all information in this manual. Any use beyond the intended use or otherwise is considered misuse.



WARNING!

Risk of misuse!

Misuse of the disc sander can lead to dangerous situations.

- Only operate the disc sander in the performance range specified in the technical data.
- Never bypass or override the safety devices.
- Never work on other materials than specified in the intended use.
- Only operate the disc sander in a technically perfect condition.
- Never work on several workpieces at the same time.

Unauthorized modifications or changes may void the CE conformity of the disc sander and are prohibited. The company Stürmer Maschinen GmbH assumes no liability for design and technical changes to the disc sander.

The improper use of the disc grinder as well as the disregard of the safety regulations or the operating instructions exclude a liability of the manufacturer for resulting damage to persons or objects and cause the warranty to expire!

3.1 Predictable misuse

With the disc sander, if the intended use is observed, no reasonably foreseeable misuse is possible, which could lead to dangerous situations involving personal injury.

3.2 Residual risks

Even if all safety regulations are adhered to, a residual risk as described below remains when operating the disc sander. All persons working with the disc sander must be aware of these residual risks and follow the instructions that prevent these residual risks leading to accidents or damage.

During set-up and set-up work, it may be necessary to dismantle on-site protective devices. This creates various residual risks and potential dangers that every operator must be aware of.

The disc sander operates at high speeds, rotating parts and electrical voltages as well as currents.

3.3 Electrical Connection



Danger!

Danger to life due to electric shock!

There is danger to life when in contact with live components. Switched on electrical components can cause uncontrolled movements and lead to serious injuries.



DANGER!

All work on the electrical installation may only be carried out by a qualified electrician.



DANGER!

The connection must be made in such a way that the grinding wheel moves in the direction of the arrow shown on the housing.

When making electrical connections, make sure that the characteristics (voltage, mains frequency, protection) match those on the rating plate and for the motor.

Operate the disc sander only on an electrical supply that fulfills the following requirements:

- The mains plug must be freely accessible.
- Protection with a residual current device (RCCB)
- Use only a grounded receptacle (properly grounded receptacle).
- Lay the power cord so that it does not interfere with work and can not be damaged.
- Protect the power cord from heat, aggressive liquids and sharp edges.

4 Technical Data

4.1 Table

Model	TS 301
Rating	750 W
Power consumption	1070 W
Speed	1400 min ⁻¹
Sanding disc diameter	300 mm
Starting current	10 A
Fuse	10 A
Dimensions Disc sanding table	390 x 230 mm
Work table pivoting	-10° / 0° / +45°
Rated current	3,6 A
Current consumption	7,0 A
Extraction port Ø	60 mm
Dimensions [LxWxH]	550 x 420 x 420 mm
Emission sound pressure level at workstation Lp (idling without extraction)	64,9 dB(A)
Sound power level Lw (idling without extraction)	77,1 dB(A)
Weight	28 kg
Protection class Engine	IP 44
Ambient temperature	5 - 35 °C
Ambient humidity	25 - 80%

4.2 Type plate

Tellerschleifmaschine Disc Sander			
Typ Type	TS 301	Serien-Nr. Serial no.	
Artikel-Nr. Item no.	5904300	Baujahr Year of manufacture	
Motorleistung Motor power	750 W	Netzanschluss Power connection	230 V / 50 Hz
		Stürmer Maschinen GmbH Dr.-Robert-Pfleger-Str. 26, 96103 Hallstadt Deutschland / Germany	

Fig. 2: Type plate

5 Transport, packaging, storage

5.1 Delivery and Transport

Delivery

Check the device for visible transport damage after delivery. If you discover damage to the device, immediately report it to the carrier or dealer.

Transport



CAUTION!

Injuries caused by parts falling over or off a forklift, pallet truck or transport vehicle.
Only use means of transport that can carry the total weight and are suitable for it.

Improper transport of individual devices, unsecured devices stacked on top of each other or next to each other in packed or already unpacked condition is accident-prone and can cause damage or malfunctions for which we do not grant any liability or guarantee.

Transport the scope of delivery secured against shifting or tilting with a sufficiently dimensioned industrial truck to the installation site.

General risks during internal transport



CAUTION: DANGER OF TIPPING!

The device may be lifted unsecured by a maximum of 2cm.
Employees must be outside the danger zone, the reach of loads. Warn employees and, if necessary, advise employees of the hazard.

Devices may only be transported by authorized and qualified persons. Act responsibly during transport and always consider the consequences. Refrain from daring and risky actions.

Gradients and descents (e.g. driveways, ramps and the like) are particularly dangerous. If such passages are unavoidable, special caution is required.

Before starting the transport check the transport route for possible danger points, unevenness and disturbances as well as for sufficient strength and load capacity.

Danger points, unevenness and disturbance points must be inspected before transport. The removal of danger spots, disturbances and unevenness at the time of transport by other employees leads to considerable dangers.

Careful planning of internal transport is therefore essential.

5.2 Packaging

All used packaging materials and packaging aids of the grinding system are recyclable and generally need to be transported to the material recycling.

Crush the packaging material made of cardboard and supply it to the waste paper collection.

The films are made of polyethylene (PE) and the upholstery parts are made of polystyrene (PS). These materials have to be delivered to a recycling station of the responsible dumping company.

5.3 Storage

The device must be thoroughly cleaned before storing it in a dry, clean and frost-free environment. Cover the device with a protective tarpaulin.

6 Description of the device

Illustrations in this manual may differ from the original.



Fig. 3: Disc sander TS 301

- 1 Sanding disc with grinding wheel
- 2 Tilttable work table
- 3 Through holes as mounting option for suitable substructures
- 4 Clamping screws for table tilt
- 5 Miter stop
- 6 On / off switch
- 7 Engine with engine brake

6.1 Scope of supply

- Disc sander
- Mitre fence
- 1 x sanding sheet Ø 305 mm, K 80
- Operating Instructions

6.2 Accessories

- Velcro pad, self-adhesive
Item number: 3357801
- Sanding sheet Ø 300 mm, K 60, velcro fastening
Item number: 5913106
- Sanding sheet Ø 300 mm, K 80, velcro fastening
Item number: 5913108
- Sanding sheet Ø 300 mm, K 100, velcro fastening
Item number: 5913110
- Sanding sheet Ø 300 mm, K 120, velcro fastening
Item number: 5913112
- Sanding sheet Ø 300 mm, K 150, velcro fastening
Item number: 5913115

7 Assembly and commissioning of the disc sander



DANGER!

Danger of electrocution!

There is danger to life when in contact with live components. Switched on electrical components can cause uncontrolled movements and lead to serious injuries.

- Disconnect the power before starting adjustments to the machine.



WARNING!

There is a risk of injury to the operator and other persons if they do not adhere to the following rules.

- The disc sander may only be operated by a trained and experienced person.
- The operator may not work while under the influence of alcohol, drugs or medication.
- The operator must not work when he is tired or suffering from concentration-impairing illnesses.
- The disc sander may only be operated by one person. Other persons must keep away from the work area during operation.



ATTENTION!

Crushing!

Incorrect work with the device can cause injury to the upper limbs.



DANGER!

- The device must not be operated in damp workplaces or outdoors in the rain.



Wear ear protection



Wear safety glasses!



Wear safety shoes!



Wear protective clothing!

7.1 Assembly

The disc sander is already pre-assembled.

Step 1: Insert the miter fence into the T-slot of the worktable.

Step 2: Remove the protective film from the engine cover so that the engine is sufficiently cooled and does not overheat.

Step 3: Attach the disc sander to a sturdy workbench. There are already 4 holes on the sanding plate for mounting (Pos.3 Fig. 3).

7.2 Commissioning



DANGER!

Danger of electrocution!

There is danger to life when in contact with live components. Switched on electrical components can cause uncontrolled movements and lead to serious injuries.

Make sure that the power supply has the same characteristics (voltage, mains frequency) as the motor.

Step 1: Check if the sanding pad does not touch the work table.



NOTE!

Please note that the freewheel of the sanding pad can not be over-checked by slightly turning the sanding pad as the motor has a motor brake.

Step 2: Check the cables and all electrical parts for external faults. Only if all parts are in order, the disc grinder may be put into operation. [In case of obvious errors, contact a specialist or your dealer.]

Step 3: The on-off switch must be in the off position.

Step 4: Connect the mains plug of the disc sander to your power supply.

Step 5: Turn the on / off switch to "on" and let the disc sander around for about 1 minute.

Step 6: After the test run of the disc sander, switch the on / off switch to "off". The engine brake brakes the engine to a standstill.

8 Operation and settings

8.1 Adjusting the angle at the work table to the sanding pad

Step 1: Check that the device is switched off and disconnected from the mains.

Step 2: The work table can be released by means of the two clamping levers left and right.

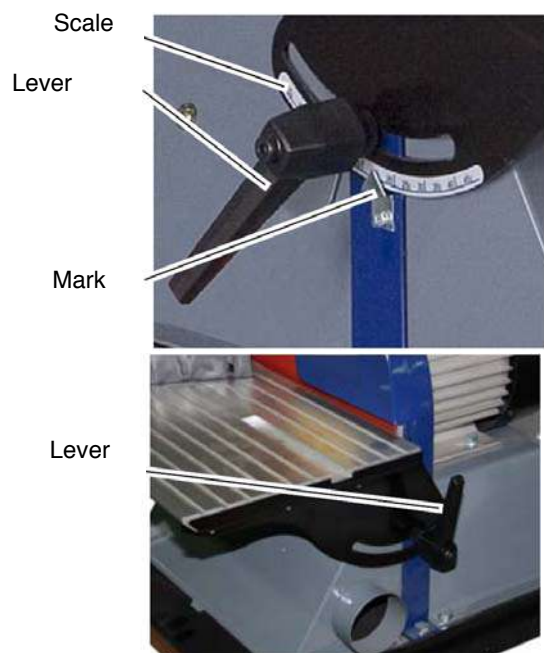

Fig. 4: Setting work table

Step 3: At both sides is a scale. In addition, a marker is attached on the left side. Use the 0 mark to set the desired angle value.

Step 4: After adjusting the angle, check the distance between the sanding plate and the work table. The distance should be 1.6 mm.

Step 5: Additionally tighten the clamping and guide screw after every angle adjustment of the table.

Step 6: Reconnect the disc sander to the power source.

For special angle settings e.g. 90 ° you can also use a stop angle and align the work table against the sanding pad [Fig. 5]. This adjustment is only an approximate view setting.

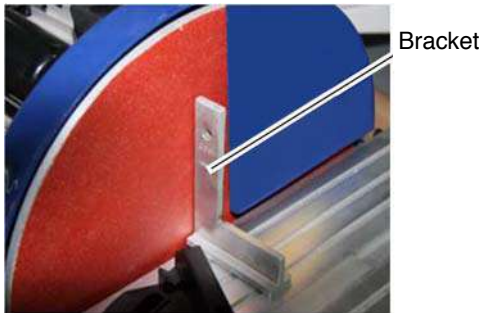

Fig. 5: Adjustment by means of stop angle

8.2 Adjusting the miter angle on the work table

Step 1: The stop angle at the work table can be released by means of the clamping screw.

Step 2: Use the scale to set the desired angles at the mark on the guide bar.

Step 3: After the adjustment, the clamping screw is tightened again and the stop angle clamped in the guide.



Fig. 6: Setting miter stop

8.3 Replacing the grinding wheel

Step 1: Disconnect the disc sander from the mains (pull the plug).

Step 2: Loosen the four screws (A / B Fig. 7) located on the right and left lids.

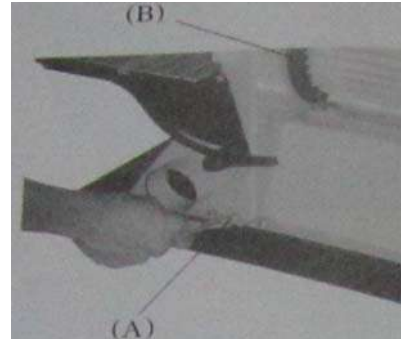

Fig. 7: Loosen the work table

Step 3: Remove the lid with the table. Now loosen the 2 screws (C) on the dust cover left and right in order to change the grinding wheel more easily.

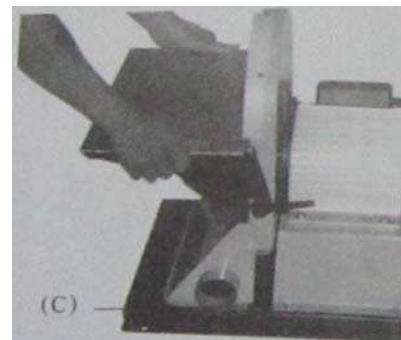

Fig. 8: Remove the work table

Step 4: Open the dust cover to change the grinding wheel more easily.

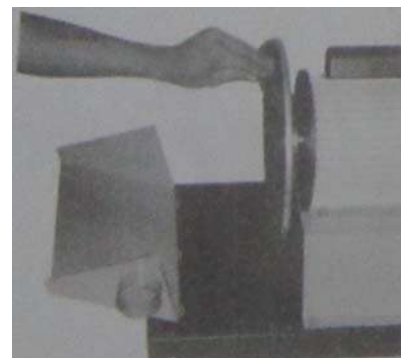

Fig. 9: Open the dust cover

Step 5: Remove the used grinding wheel from the sanding pad. Clean the sanding pad from the glue residue and other contaminants. Use a suitable solvent, for example nitro diluent, for removal.



WARNING!

- Many cleaning agents are flammable and highly flammable. Some solvents are also hazardous to health. It is essential to follow the instructions of the cleaning or solvent manufacturer. Do not smoke while handling cleaning or solvents. Fire and open light are forbidden!

Step 6: Now you can apply the new velcro pad. When attaching the Velcro pad, pay attention to an oil and grease-free surface.

Step 7: Mount the grinding wheel (with Velcro) on the Velcro pad.

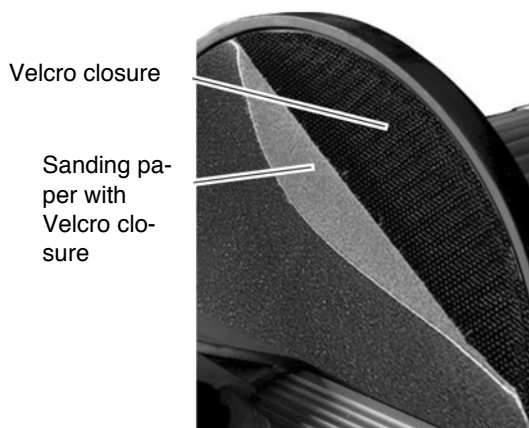

Fig. 10: Assembly of the grinding wheel

Step 8: Reinstall the grinding wheel cover or worktable. Observe the freewheel of the sanding pad to the work table (adjust the distance if necessary).



NOTE!

Please note that the freewheel of the sanding pad can not be over-checked by slightly turning the sanding pad as the motor has a motor brake.

Schritt 9: Step 9: Reconnect the disc sander to the power source.



NOTE!

To replace the aluminum pad, hold the motor shaft with a wrench and turn the plate in the opposite direction so that the pad can be removed from the motor shaft.

8.4 Connection to an extraction system

Step 1: On the right side under the work table there is a connection piece (Ø 60 mm) for connection to an extraction system.

Suction socket

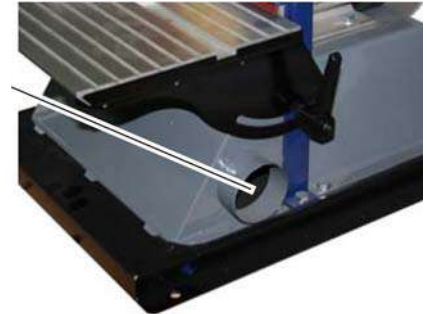

Fig. 11: Suction socket

8.5 Grinding



DANGER!

Before using for the first time, check the functions of the disc sander.

If a malfunction or malfunction occurs, turn off the power and unplug the power cord. Do not operate the device until all faults have been eliminated.



WARNING!

Risk of injury

Check the function of the safety devices before switching on.

Danger of injury by tilting away the workpiece!
Position the workpiece stably and securely so that it can not move by the pressure of the machine against the edges and the pressure on the surface.



Wear ear protection



Wear safety glasses!



Wear safety shoes!



Wear protective clothing!



WARNING!

Risk of injury

By grinding with the material, do not press too hard against the sanding pad.



WARNING!

Risk of injury

Make sure that the gap between the work table and the grinding wheel is not too large. Especially with thin workpieces, there is a risk that the workpiece will enter the gap.

Since the machine has no clamping facility, it is important that your workpiece is resting on the work table over the entire surface and can be held fast!



NOTE!

Before starting grinding always check whether the workpiece is free of oil, grease and paint residues. This prevents smearing or soiling of the grinding wheel. Pay attention to the condition of the grinding wheel and check whether the grinding wheel is mounted correctly. If the grinding wheel is dirty or damaged, it must be replaced. Only with perfect tools you can achieve a good grinding quality!

Note the possible (hatched) working area of the disc sander. Machining workpieces in the non-hatched area can lead to dangerous situations.

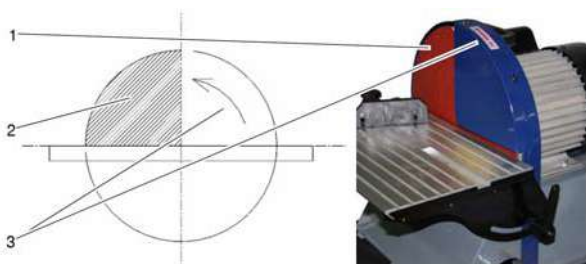

Fig. 12: Work area sanding pad

- 1 Sanding disc with grinding wheel
- 2 Workspace
- 3 Direction of rotation

Step 1: Before starting, check the plug and the cable.

Step 2: Check if the worktable is tight.

Step 3: Check that the correct sanding pad is mounted with the right grain size.

Step 4: Connect suction system and start.

Step 5: Turn on the disc sander by pressing the green "On" button.

Step 6: Execution of the grinding process.

Step 7: After completing the sanding process, switch off the disc sander by pressing the red "Off" button. The integrated motor brake brakes the grinding wheel to a standstill.

Step 8: Turn off the exhaust system.

Step 9: Pull the power plug of the disc grinder.

9 Care, maintenance and repair



DANGER!

Danger to life due to electric shock!

There is danger to life when in contact with live components. Switched on electrical components can cause uncontrolled movements and lead to serious injuries.

- Disconnect the mains plug before starting cleaning and maintenance work.



DANGER!

- Never use solvents to clean plastic parts or painted surfaces. A surface release and consequential damage may occur.

9.1 Cleaning after work

The disc sander should always be kept in a clean condition.



Wear safety gloves!



NOTE!

Never use harsh cleaning agents for cleaning. This can lead to damage or destruction of the device.

Step 1: Disconnect the power plug from the power outlet.

Step 2: At regular intervals, turn off the appliance with a hand brush or wipe it with a soft, moistened cloth.

9.2 Maintenance and repair

Repair work may only be carried out by qualified personnel.

If the disc sander does not work properly, contact a dealer or our customer service. The contact details can be found in chapter 1.2 Customer Service.

All protection and safety equipment must be reinstalled immediately after completion of repair and maintenance work.

10 Troubleshooting

Fault	Possible causes	Disposal
Motor overloaded	1. Cooling air intake of the engine impeded. 2. Contact pressure too high.	1. Check and clean. 2. Work with less contact pressure.
Engine does not start as soon as you press the power button	1. Connection cable damaged or loose 2. Power switch is defective	1. Check / renew connection cable 2. Check / replace the switch.
Engine is not running at full speed	1. Voltage is too low or motor is defective	1. Have the voltage and motor checked by a qualified electrician.
Workpiece is retracted	1. Distance between grinding wheel and work table too large.	1. Reduce the distance between the grinding wheel and the work table.
Low service life of the grinding wheel	1. Grinding wheel with too fine grain.	1. Use a grinding wheel with a coarser grain size.
Bad sanding pattern	1. Grinding wheel with coarse grain.	1. Use grinding wheel with finer grain size.
Sanding pattern does not fit	1. Adjusted angles on the work table or on the stop bracket do not fit.	1. Check the angle and readjust if necessary.
Grinding wheel runs optically out of round	1. Grinding wheel applied off-center.	1. Apply the grinding wheel in the middle.

11 Disposal, recycling of old equipment

In your own interests and in the interests of the environment, please ensure that all components of the machine are disposed of in the proper and approved way.

11.1 Decommission

Discarded appliances are immediately professionally decommissioned, in order to avoid any later misuse and the threat to the environment or people.

Step 1: Remove all environmentally hazardous fluids from the old device.

Step 2: If necessary, dismantle the machine into manageable and usable assemblies and components.

Step 3: Guide the machine components and operating materials to the appropriate disposal routes.

11.2 Disposal of electrical appliances

Please note that electrical units contain a variety of recyclable materials and environmentally harmful components.

Please contribute that these components are separated and disposed of properly. If in doubt, contact your municipal waste.

For preparation for commissioning please contact a company specialized for disposal.

11.3 Disposal of lubricants

The disposal instructions for the lubricants used are provided by the lubricant manufacturer. If necessary, ask for the productspecific data sheets.

11.4 Disposal via municipal collection points

Disposal of used electrical and electronic equipment (Applicable in the countries of the European Union and other European countries with a separate collection system for these appliances).



The symbol on the product or its packaging indicates that this product should not be treated as normal household waste, but must be returned to a collection point for the recycling of electrical and electronic equipment. By helping to properly dispose of this product, you are protecting the environment and the health of others. Environment and health are endangered by improper disposal. Material recycling helps to reduce the consumption of raw materials. For more information about recycling this product, contact your local community, municipal waste management, or the shop where you purchased the product.

12 Spare parts



DANGER!

Danger of injury by the use of wrong spare parts!

Dangers may result for the user and damages as well as malfunctions may be caused by using wrong or damaged spare parts.

- Only use original spare parts of the manufacturer or spare parts admitted by the manufacturer.
- Always contact the manufacturer in case of uncertainties.



NOTE!

Using non-approved spare parts voids the manufacturer's warranty.

12.1 Ordering spare parts

The spare parts may be purchased with the authorised dealer .

Indicate the following basic information for spare part orders:

- Type of device
- Serial number
- Quantity
- Designation
- Required mode of dispatch (mail, freight, sea, air, express)
- Address of dispatch

Spare part orders which do not include the above indications may not be taken into consideration. If the indications regarding the mode of dispatch are missing, the product is dispatched at the discretion of the supplier.

Information on the device type, item number and year of manufacture can be found on the nameplate, which is attached to the machine.

Example

The engine for the Disc sander TS 301 must be ordered. The engine has the number 48 in the spare parts drawing 1.

By ordering spare parts, send a copy of the spare parts drawing (1) with the marked part (engine) and marked position number (48) to the dealer or spare parts department and provide the following information:

- Type of device: **Disc sander TS 301**
- Item number: **5904300**
- Drawing number: **1**
- Position number: **48**

12.2 Spare parts drawing TS 301

The following drawing is intended to help in case of service, to identify necessary spare parts. To order send a copy of the parts drawing with marked components to your dealer.

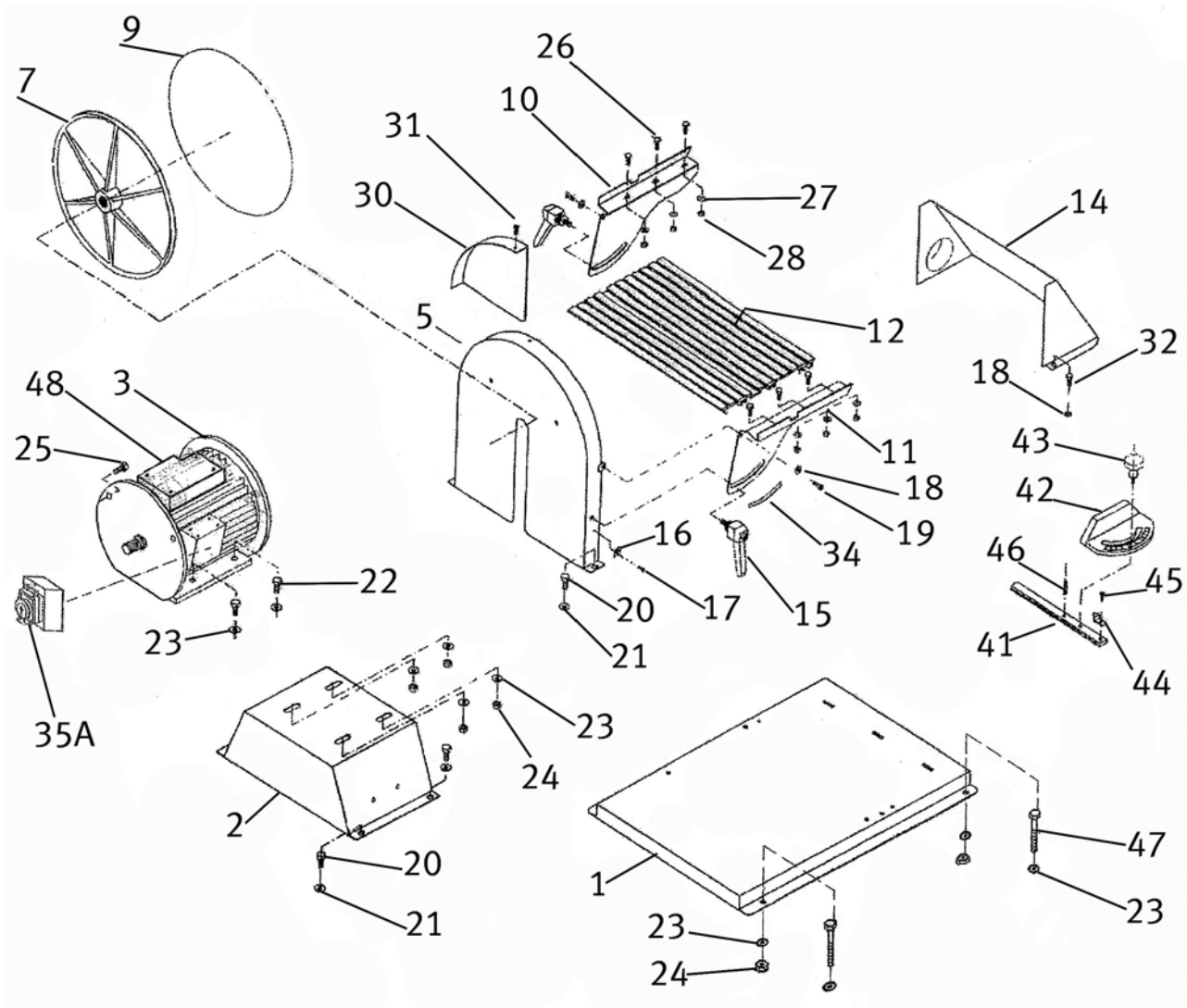

Fig. 13: Spare parts drawing Disc sander TS 301

13 Wiring Diagram

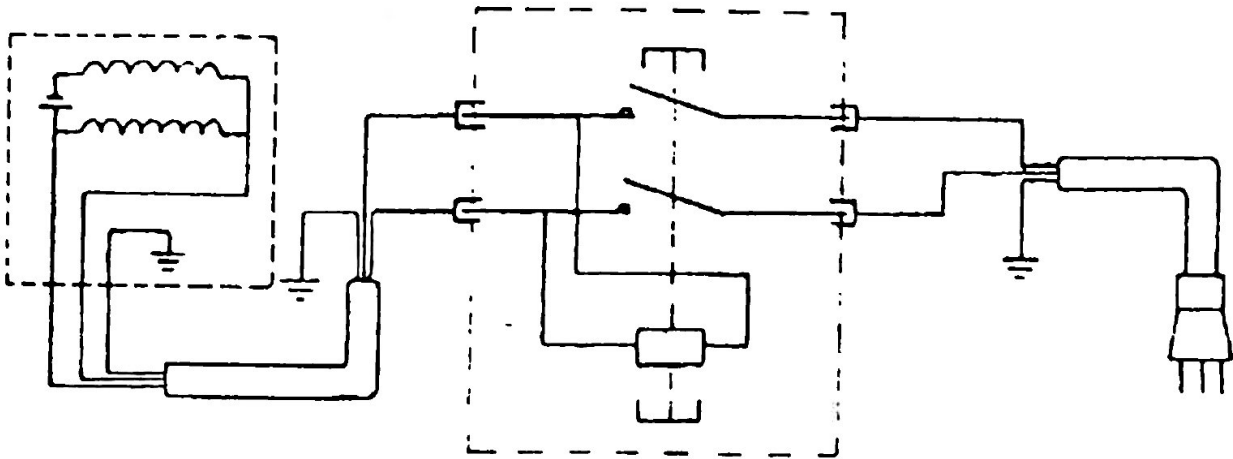

Fig. 14: Wiring Diagram Disc sander TS 301

14 EC-Declaration of Conformity

According to Machinery Directive 2006/42/EC Annex II 1.A

Manufacturer / distributor: Stürmer Maschinen GmbH
Dr.-Robert-Pfleger-Str. 26
D-96103 Hallstadt

hereby declares that the following product

Product group: Holzkraft® Wood working machines

Machine type: Disc sander

Description of the machine: TS 301

Item number: 5904300

Serial number*: _____

Year of manufacture*: 20____

* please fill in according to the information on the type plate

corresponds to all the relevant provisions of the abovementioned Directive and other Directives applied (below) - including their amendments current at the time of the declaration.

Relevant EU Directive: 2014/30/EU EMC-Directive
2012/19/EU WEEE-Directive

The following harmonized standards were applied:

DIN EN 60204-1:2019-06 Safety of machinery - Electrical equipment of machines - Part 1: General requirements

DIN EN ISO 12100:2011-03 Safety of machinery. General principles for design Risk assessment and risk reduction

Responsible for documentation: Kilian Stürmer, Stürmer Maschinen GmbH,
Dr.-Robert-Pfleger-Str. 26, D-96103 Hallstadt

Hallstadt, 25.05.2021



Kilian Stürmer
Manager



